

MECHANICS



UDC 531.36

<https://doi.org/10.23947/2687-1653-2021-21-1-32-42>

Material point physical model rationale while studying kinematic characteristics of a motor vehicle in case of oblique collision with side cable barriers



G. P. Kolesnikova

Peter the Great Military Academy of the Strategic Missile Troops (Balashikha, Russian Federation)

Introduction. A review of the application of theoretical mechanics methods for the development of algorithms of approximate analytical simulation of a motor vehicle (MV) movement in case of oblique collision with side cable barriers is performed. The representation of the MV as a material point in this type of collision is validated. The study objective is to demonstrate the application of a physical model of a material point to describe the motor vehicle dynamics in the event of its oblique collision with side cable barrier.

Materials and Methods. A new physical model that describes the opposition to the motor vehicle movement from the side of a cable barrier in an oblique collision is proposed. New methods of approximate analytical construction of the MV movements during an oblique collision with the side cable barriers are presented. The analytical calculation results are verified by the data of the finite element (FE) simulation of the collision according to the data of field tests. The FE simulation was carried out using a multi-purpose finite element complex LS-Dyna.

Results. New analytical algorithms have been developed for the MV movement in case of an oblique collision with side cable barriers, as well as a new physical model describing the opposition to the MV movement from the side of cable barriers. The application of a physical model of a material point to study the motor vehicle dynamics during an oblique collision with side cable barriers is established scientifically, including the comparative analysis of the kinematic results of the virtual test with kinematic calculations obtained on the basis of algorithms for analytical construction of the MV movements.

Discussion and Conclusions. The analysis of the kinematic results of the virtual test in comparison with the analytical kinematic calculations has shown that the representation of a motor vehicle as a material point in case of an oblique collision with side cable barriers is reasonable since the MV movement is close to translational motion. The results obtained can be used in the development and analysis of the correctness of the FE modeling of a side collision of a motor vehicle with cable barriers.

Keywords: cable barrier, analytical modeling, motion trajectory, displacements, material point, motor vehicle, oblique collision.

For citation: G. P. Kolesnikova. Material point physical model rationale while studying kinematic characteristics of a motor vehicle in case of oblique collision with side cable barriers. Advanced Engineering Research, 2021, vol. 21, no. 1, p. 32–42. <https://doi.org/10.23947/2687-1653-2021-21-1-32-42>

© Kolesnikova G. P., 2021



Introduction. Safety systems designed for the organization of traffic flows on road routes help to minimize the adverse consequences of road traffic accidents (RTA). Currently, cable road barriers are gaining popularity. They are installed on the road dividing strip to prevent intentional and unintentional crossing of the road by vehicles, as well as

on the roadsides, to prevent the departure of vehicles outside the road¹. Different structures of cable barriers consist of common elements: cables, racks, anchor blocks, clamping devices, but differ in the type of their installation² [1-4], in particular, in the method of fastening the cables (Fig. 1), which significantly affects the development of mathematical models. The behavior of the racks under the MV collision is also different. Racks can be crushed or, coming out of the sleeves, assembled with one another, and thus provide additional braking of the MV [5].

The collision of a car with a cable barrier is characterized by complex interaction mechanics, since the cables have a high degree of geometric nonlinearity, and the racks and the ground have a high degree of physical nonlinearity, while almost all processes are transient [5].



Fig. 1. Some types of cable racks [6]

To determine the MV trajectory, string vibration equations can be used in the analytical calculations of arresters^{3,4} and cable-stayed structures^{5,6}. But due to the complexity of the construction of barriers, there are difficulties in the formulation of boundary conditions. Energy methods also give a set of equations that are not solved analytically⁷ [7]. All this causes the need to study barriers with the help of engineering software packages for both modeling the cable barrier itself and the crash test system. In this case, the numerical finite element method in the explicit formulation is often used, which is implemented in the software complexes LS-DYNA, MARC, NASTRAN, etc. [5, 8, 9].

The disadvantages of building FE models are the following: the development complexity; the duration of the calculation period (120 hours or more); the need to check the correctness of the construction. Thus, the period of preparation of the basis for the study is quite long. In this regard, a method of approximate analytical calculation of the MV movement from the data of field tests, based on the methods of theoretical mechanics, is proposed. The analytical calculation provides checking the correctness of the developed FE model, as well as reducing the time of the passive safety study by 2-3 times, since for the analysis of passive safety, it is no longer necessary to build a FE model of the cable barrier itself, but to use the analytically obtained movements.

Materials and Methods. As a result of observing the MV during full-scale crash tests, a hypothesis was put forward: in case of the collision with the side cable barriers, the MV can be represented as a solid body making a translational motion (Fig. 2).

¹ Industry road methodological document ODM 218.6.017-2015. Guidelines for the use of road barriers of various types on federal highways, recommended by the order of the Federal Road Agency, dated December 23, 2015, no. 2489-r. URL: <https://files.stroyinf.ru/Data2/1/4293757/4293757596.pdf> (accessed: 08.01.2021). (In Russ.)

² Horne DA. Report 350 Acceptance of New York Three-Strand Cable Terminal. Office of Highway Safety Infrastructure, FHWA, U.S. Department of Transportation – Washington, D.C.; February 14, 2000. Available from: <https://highways.dot.gov/> (accessed: 21.01.2019).

³ Nuralieva AB. On dynamics of the space elevator cable: Cand.Sci. (Phys.-Math.), diss., author's abstract. Moscow, 2012. 20 p. (In Russ.)

⁴ Mikhailiuk DS. Finite element modeling and research on the dynamics of a deck arrester: Cand.Sci. (Eng.), diss., author's abstract. St. Petersburg, 2009. 19 p. (In Russ.)

⁵ Dyadkin SN. Rationale, technology of balanced erection and monitoring of byte bridge spans with account for climatic factors (case study: the bridge over the Ob River near Surgut): Cand.Sci. (Eng.), diss., author's abstract. Volgograd, 2005. 20 p. (In Russ.)

⁶ Le Thu Huong. Optimization of parameters of spans of suspension bridges, reinforced and not reinforced with inclined cables, when designing them with using PC: Cand.Sci. (Eng.), diss., author's abstract. Moscow, 1999. 25 p. (In Russ.)

⁷ Los MV. Numerical modeling of the behavior of the "body-rope" system with account for flexural rigidity of the cable and mechanism of looping: Cand.Sci. (Phys.-Math.), diss., author's abstract. Moscow, 2000. 19 p. (In Russ.)

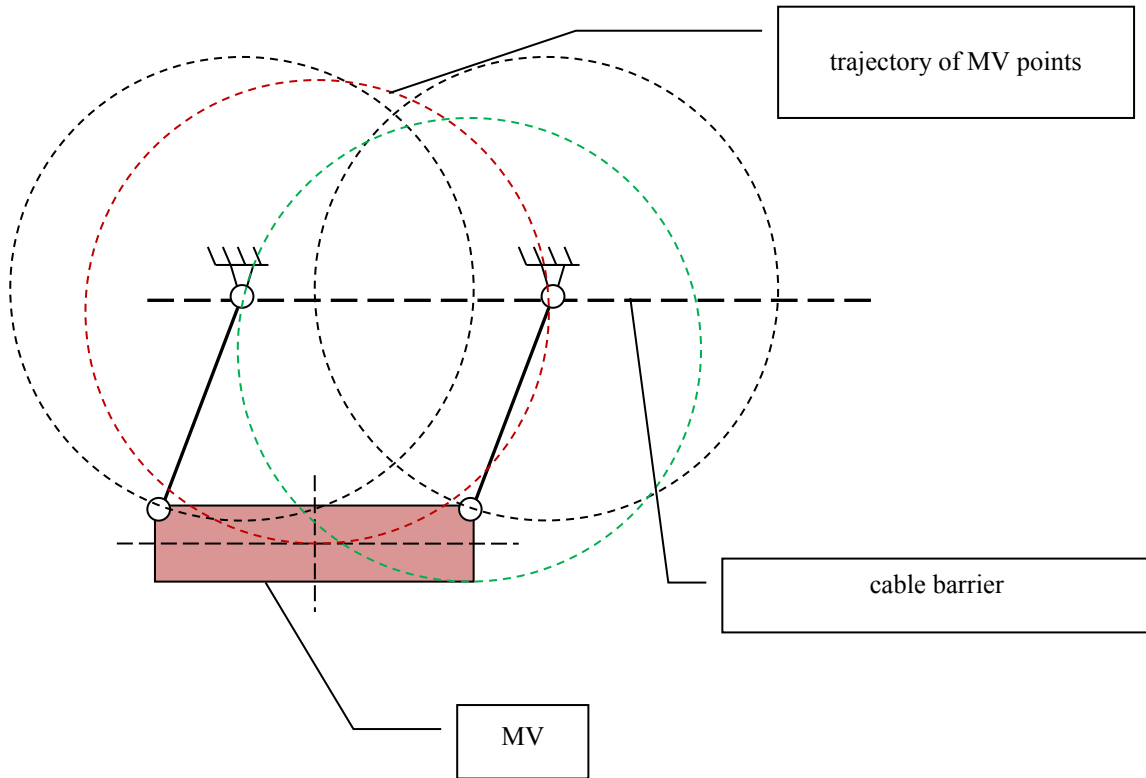

Fig. 2. The model of MV as a solid body performing translational motion

In addition, a number of fundamental assumptions on the dynamics of the MV during an accident are made, justifying the use of the proposed theoretical and mechanical models of the phenomenon:

- the lateral and longitudinal decelerations of the vehicle are constant during the time interval required for the MV to be oriented parallel to the undeformed barrier;
- vertical and rotational accelerations of the vehicle are ignored;
- the lateral component of the speed is zero after the vehicle is redirected parallel to the guardrail;
- as the vehicle is being redirected, it does not engage with the guardrail;
- the deformation of the vehicle occurs in the collision zone, but its center-of-gravity position does not change significantly;
- the MV center of mass moves as if all its mass is concentrated at this point;
- the barrier can be rigid or flexible;
- the friction forces of the car tires on the road surface are ignored;
- the guardrail system does not contain breaks that can cause sudden vertical movements of the vehicle.

With this representation of motion, a MV (Fig. 3) can be considered as a material point of some mass m [10]. The Cartesian coordinate system origin corresponds to the point of origin of contact between the vehicle and the barrier. The motion of the material point begins with at the speed \vec{v}_0 , directed at an angle α to the plane of the fence (x -axis) [6].

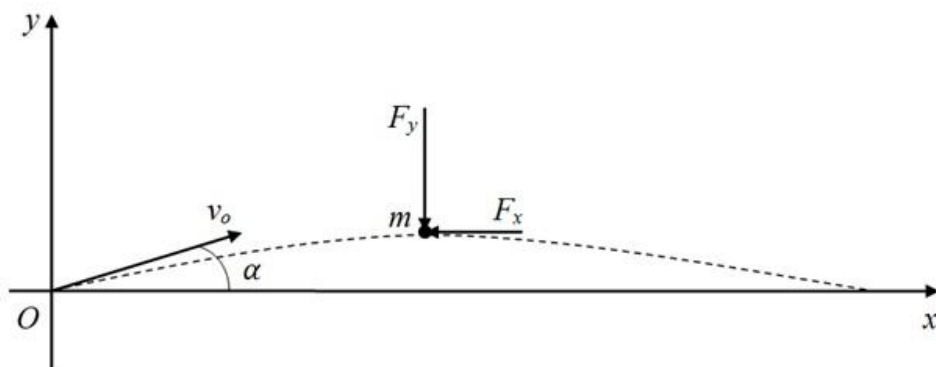

Fig. 3. Calculation scheme of MV [6]

The opposition to the movement of the vehicle from the side of the cable barrier was modeled by the forces [6]:

— with lateral deviation along the y -axis — by the elastic force $P_y = -ky$ and dissipative resistance

$$P_y^{diss} = -b\dot{y}, \text{ i.e., } F_y = -ky - b\dot{y};$$

— the opposition to movement along the x -axis — by the force of friction $F_x = -fN_l$, where N_l — the force of inertial pressure, i.e., $N_l = m\ddot{y}$ [6].

As a result, the MV motion is described by a system of differential equations [6, 11]:

$$\begin{cases} \ddot{x} = -f\ddot{y}; \\ \ddot{y} + 2\varepsilon\dot{y} + p^2y = 0. \end{cases}$$

The solution to the system is displacement as a function of time t :

$$\begin{cases} x(t) = -fy(t) + v_0(\cos\alpha + f\sin\alpha)t; \\ y(t) = \frac{v_0\sin\alpha}{p}e^{-\varepsilon t}\sin pt. \end{cases}$$

In [6], it is proved that the Coulomb friction force from the side of the road barrier does not significantly affect the simulated the MV motion. Physical modeling of the MV as a material point is not new under studying the case of collision with lateral barriers. This approach was used by R. M. Olson, E. R. Post and F. F. McFarland when describing a car hitting a rigid bridge guardrail [12]. Here, the calculation of the side barrier resistance was based only on the classical Amontons-Coulomb model of friction.

In contrast to the problem, the nature of the interaction between the MV and the barrier is described in this paper by a fundamentally new model. With the external similarity of the problem statement, the physical essence of the interaction between the MV and the barrier differs qualitatively from the essence of the interaction with more rigid fences. In our paper, this was taken into account through the Amontons-Coulomb force models considering the force of the inertial normal pressure and the Kelvin-Voigt resistance model.

Also, in the context of the study on the nature of the impact on cable barriers, the paper by M. B. Bateman and others should be mentioned [9]. The data of full-scale tests presented in this work demonstrate clearly that in case of oblique collision with cable barriers, the MV motion is close to translational one, when the yaw angle does not exceed 10° . Here, the head-on crash process is described by two models:

1. A simple dynamic model of a vehicle, where the Runge-Kutta fourth-order method was used for the numerical solution to the differential equation of the MV motion. In this case, the forces of action from the side of the barrier (cable tension) and the road (friction force according to the classical Amontons-Coulomb model) are considered. The wheels are not assumed to require steering under impact.

2. A quasistatic model of the barrier, which is designed to calculate the change in tension of the cables when their geometry changes as a result of the movement of the car.

As a result, the computational model is quite cumbersome and requires a numerical solution, whereas the model proposed in this paper provides calculation algorithms that are easily carried out analytically without the use of numerical methods.

Approximate analytical calculation of the MV kinematic characteristics. As a result of the assumptions made, an algorithm for constructing the MV motion called harmonic has been obtained [6]. Further, we propose quadratic and cubic algorithms based on the construction of polynomial displacement functions [13].

Here, the opposition to the MV motion from the side of cable barriers along the y -axis is determined by some function $P_y(t)$, the result of its integrating is as follows: the MV displacement function along the y -axis has the character of a second or third order polynomial. The simulation of the opposition to the movement along the x -axis remains the same.

We will conduct a comparative analysis of the results of the approximate analytical calculation of the MV kinematic characteristics. Fig. 4-6 show the computation data for bus Mercedes-Benz O345. When constructing the movements of the MV, data of field tests of the State Research Center of the Russian Federation FSUE "NAMI" were used.

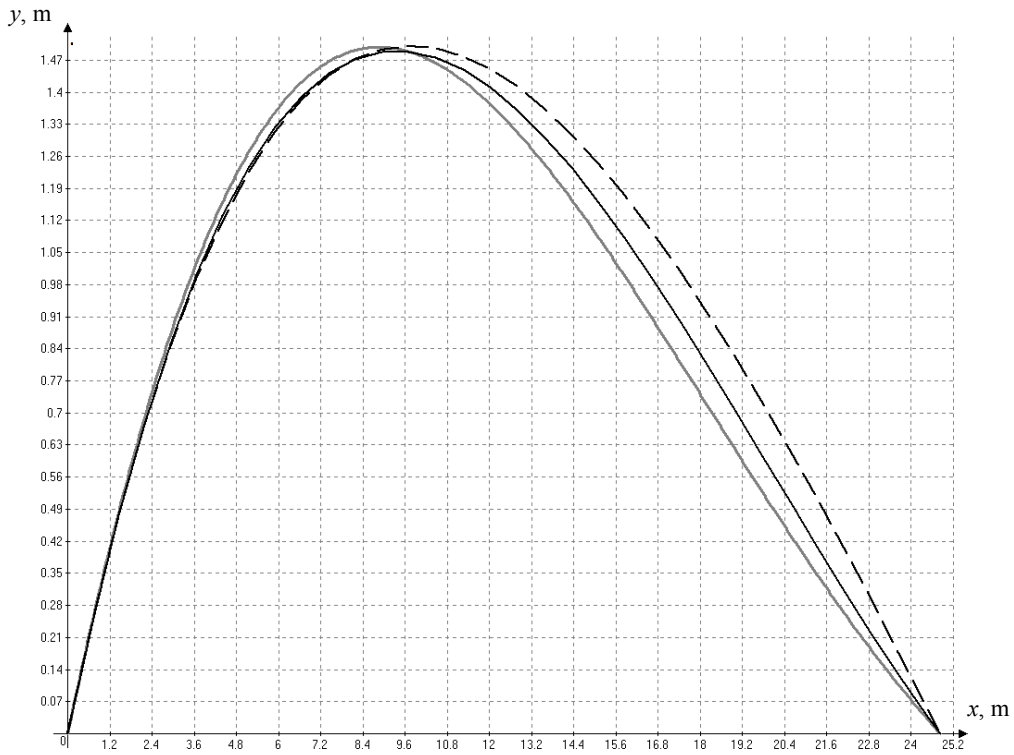

Fig. 4. Interdependence of the deviations x, m , and y, m , calculated by the methods of cubic approximation — black solid line; quadratic approximation — dotted line; harmonic approximation — gray line [13]

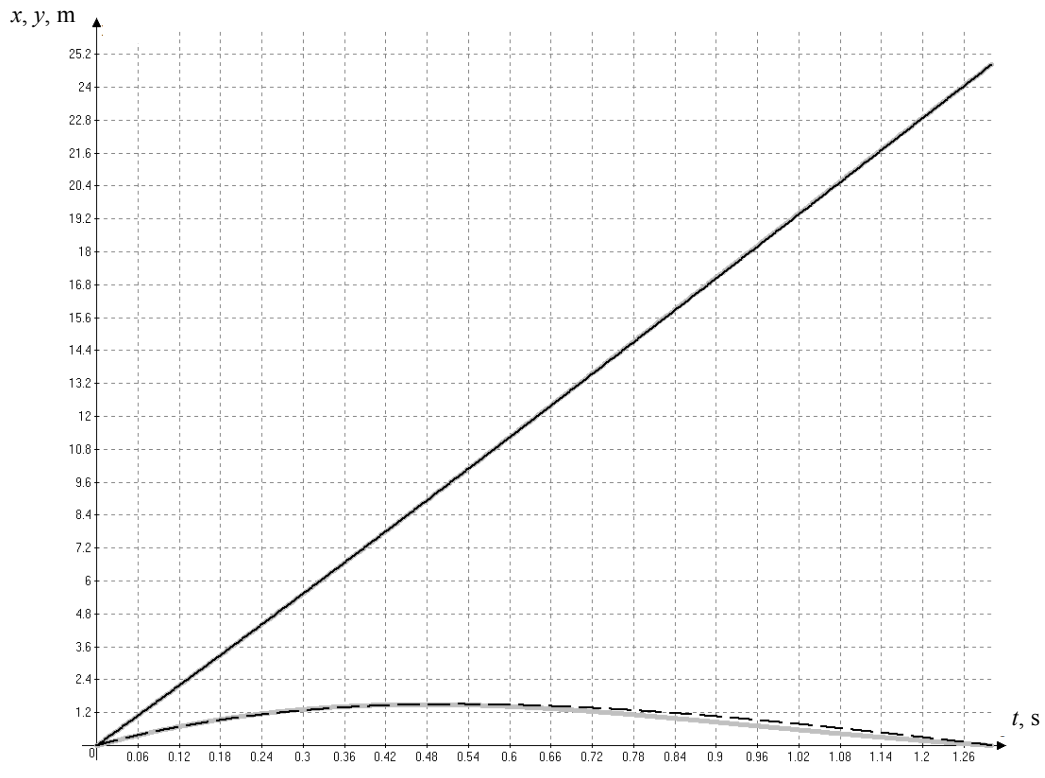

Fig. 5. Dependences of the deviations x, m , and y, m , on time t, s , calculated by the methods of quadratic harmonic approximation along the x -axis — black solid line; along the y -axis: dotted line — by the method of quadratic approximation, gray line — by the harmonic approximation method [13]

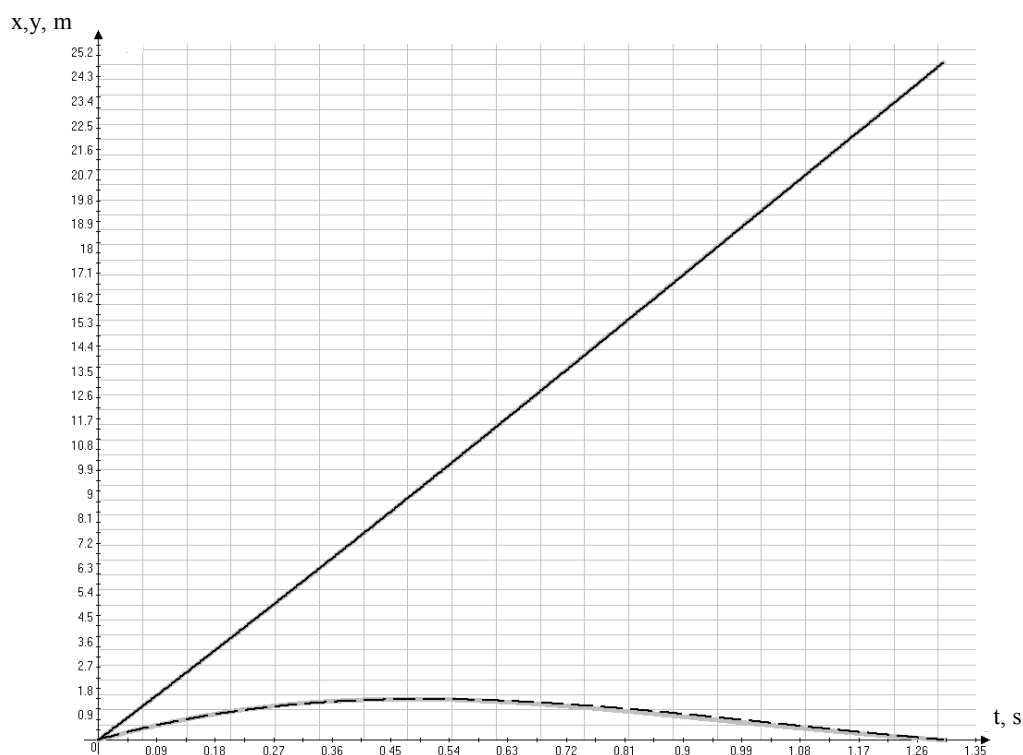

Fig. 6. Dependences of the deviations x , m, and y , m, on time t , s, calculated by the methods of cubic and harmonic approximation along the x -axis — black solid line; along the y -axis: dotted line — by the method of cubic approximation, gray line — by the harmonic approximation method [13]

As can be seen from the above calculated data, the divergence of analytical methods does not exceed 20 %. The same calculations were carried out for car GAZ-3102 [12].

Construction of a finite element model of the contact of the cable barrier and bus Mercedes-Benz-0345.

To analyze the performance of the approximate method of constructing the MV trajectory, a FE-model of the interaction of the cable barrier and bus Mercedes-Benz-0345 was developed in accordance with the industry standard STO 521000-005-10690827-2015¹, agreed with Rosavtodor in 2017. According to this standard, the installation of cable barriers for tests was carried out; the test results were also used in the analytical modeling of the trajectories and deviations of the MV. The object of virtual tests were cable barriers of 14DD/U 4(300)-P-1, 1-3, 0-GB brand [11, 13] with the following parameters:

- octagonal sleeves of GZ 500/U brand;
- STD-2 racks consist of two elements in the form of a square pipe with a length of 1500 m with a cross-section size of $50 \times 50 \times 3$ mm;
- spacing of racks with concreted sleeves at the working area — 3 m;
- spacing in the initial and final sections — 2 m;
- the height of the racks above the road surface — 1.1 m.

Cable parameters:

- three-strand, seven-conductor;
- diameter — 19 mm;
- rated breaking force ≈ 173 kN;
- the number of branches — 4.

Bus Mercedes-Benz-0345 parameters [12, 13]:

- gross mass — 14,050 kg;
- overall length — 12,000 mm;
- overall width — 2,500 mm.







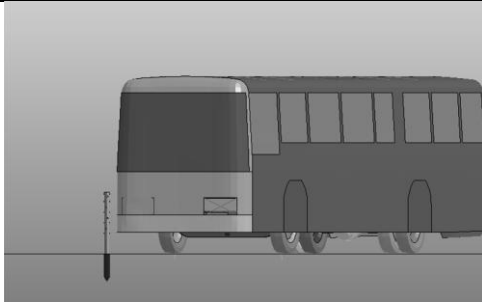

The speed of the MV coming into contact with the barrier is 69 km/h. The angle between the plane of the barrier and the direction of the MV movement — 20° in accordance with the methodology of GOST R 52721-2007

¹STO 521000-005-10690827—2015. Retaining side barriers for vehicles with the use of a C-section of a beam. “PIK” Enterprise. rosavtodor.gov.ru URL: https://rosavtodor.gov.ru/storage/app/media/rosavtodor/b/2016/02/09/sto_521000_005_10690827_2015.pdf (accessed: 10.01.2021). (In Russ.)

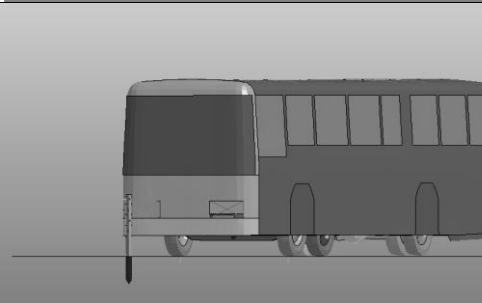

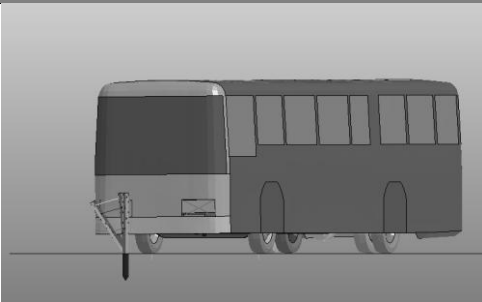

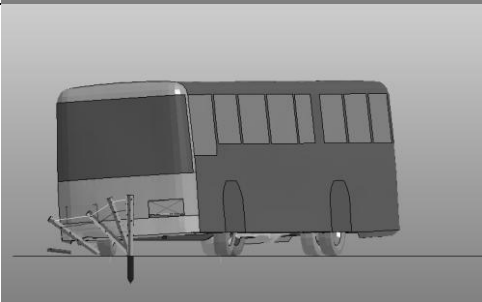
(nos. 6.1–6.6) [11, 13]. Time-lapse images of the MV according to the data of full-scale¹ and virtual tests are presented in the Table 1.

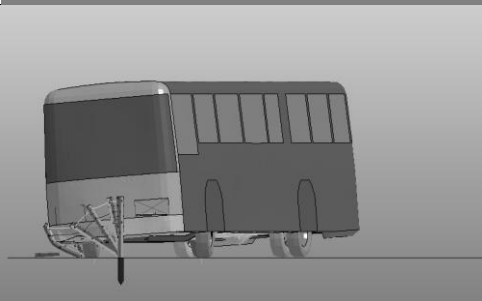
Table 1

Comparative frame-by-frame images of MV

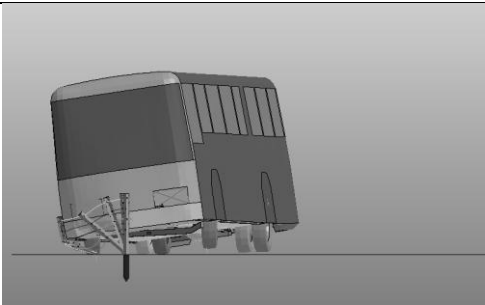
Timepoint t , s	Test mode	
	full-scale	virtual
0.00		
0.16		
0.32		
0.48		
0.64		

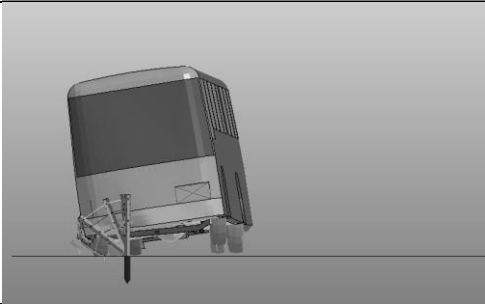
¹STO 10690827-001—2015. Lateral deformable road barriers, cable type. Specifications. “PIK” Enterprise. rosavtodor.ruwwwrosavtodor.ru URL: <http://rosavtodor.ruwww.rosavtodor.ru/storage/app/media/uploaded-files/sto-10690827-001-2015.pdf> (accessed: 08.01.2021). (In Russ.)

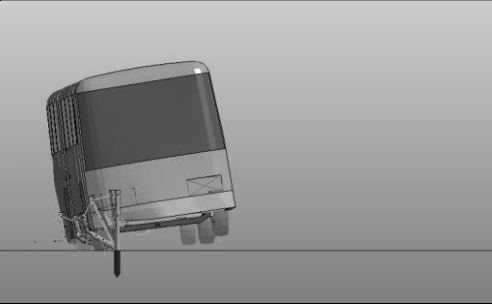
Timepoint t , s	Test mode	
	full-scale	virtual
0.80		
0.96		
1.12		

The field test results practically coincided with the results of the virtual tests, since in both cases, the dynamic deflection of the barrier was 1.5 m; the path length of the interaction of the MV and the barrier from the calculation was 23.5 m, according to the field tests — 25 m. The relative error of the path length of the interaction did not exceed 6 %.

Research Results. As a result of a virtual test using the developed FE-model of the cable barrier, the trajectories of the characteristic points of bus Mercedes-Benz-0345 were determined. Fig. 7 shows the points of the MV for which the readings were taken, point C corresponds to the center of gravity.

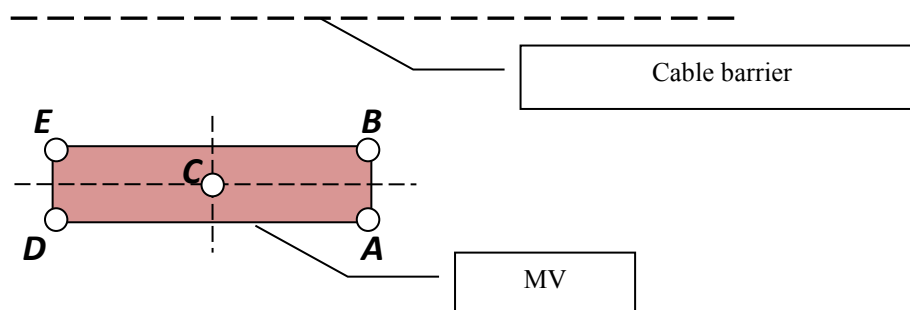

Fig. 7. MV points selected for analysis: A , B — on the frontal surface; D , E — on the rear surface

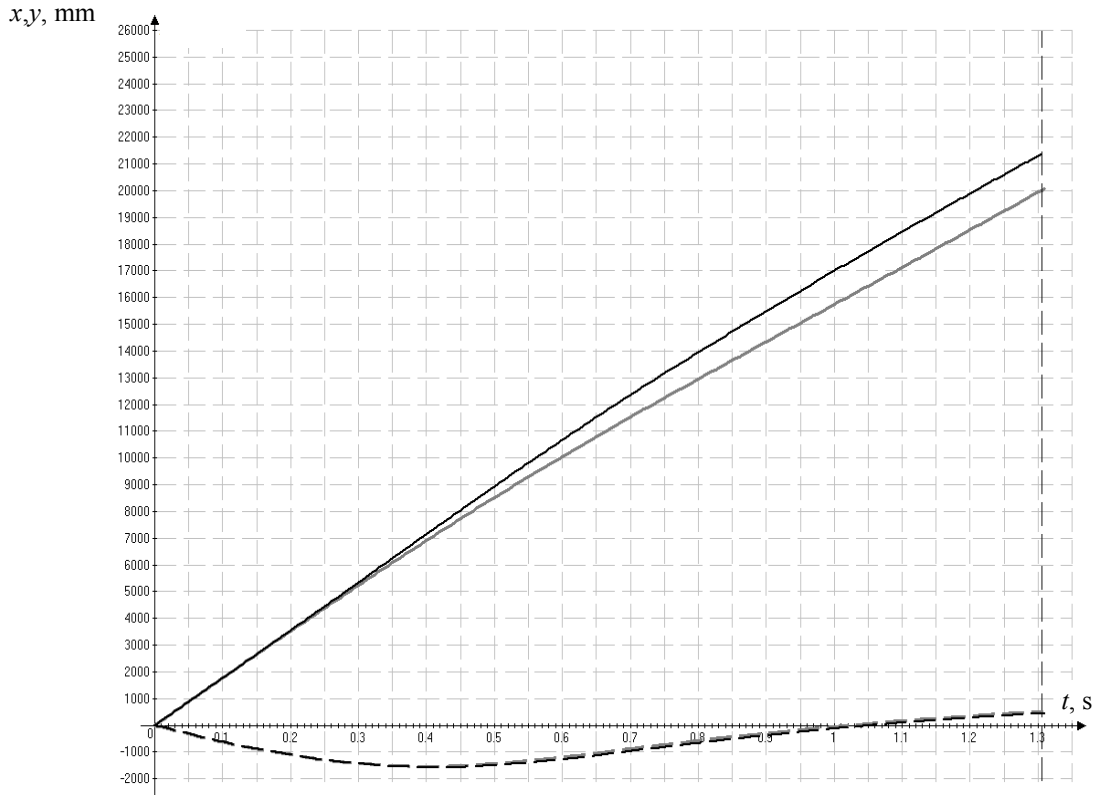

Fig. 8. Dependence of displacements of the MV characteristic points on time.
Dotted line — for points *A* and *B* along the *y*-axis; solid lines — along the *x*-axis:
black — for point *A*, gray — for point *B*

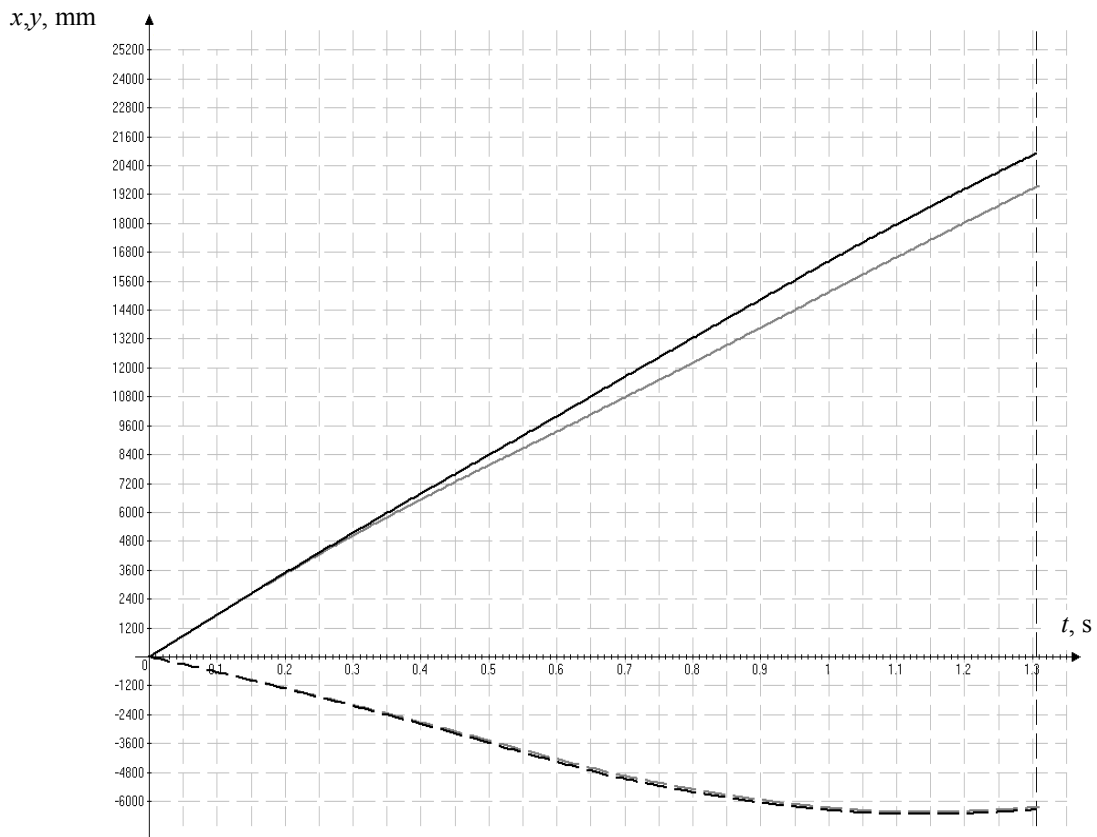

Fig. 9. Dependence of displacements of the MV characteristic points on time.
Dotted line — for points *D* and *E* along the *y*-axis; solid lines — along the *x*-axis:
black — for point *D*, gray — for point *E*

As can be seen from the presented data, the displacements of points *A*, *B*, and *D*, *E* along the *y*-axis match in pairs. The same can be observed for speeds. Thus, in case of oblique collision of the MV with the side cable barriers, the movement of the MV is really close to translational.

Discussion and Conclusions. The analysis of the kinematic results of the virtual test in comparison with the kinematic analytical calculations shows that the representation of the MV as a material point in case of its oblique collision with the side cable barriers is justified, since the movement of the MV is close to the translational one. However, if necessary, for a more accurate analytical calculation of the kinematic characteristics of the motion of points located in areas close to the points *C*, *D*, *E*, an additional analytical calculation is required, for example, using the equations of plane-parallel motion of a solid body.

References

1. McClanahan D, Albin RB, Milton JC. Washington State Cable Median Barrier In-Service Study. In: Presentation at the 83-rd Annual Meeting of the National Transportation Research Board, Washington D.C.; 2004. Available from: <http://www.wsdot.wa.gov/publications/fulltext/Policy/CableBarriersubmittalforTRB.pdf> (accessed: 02.11.2020).
2. Amato G, Ghosh B, O'Brien F, et al. A scaling method for modeling the crashworthiness of novel roadside barrier designs. *International Journal of Crashworthiness*. 2013;18(3):317. Available from: <https://www.tandfonline.com/doi/full/10.1080/13588265.2013.783429>. (accessed: 23.11.2020).
3. Tuan ChY, Sarmah RD, Tuan AY, et al. Progressive failure simulation of security cable barriers. *International Journal of Nonlinear Sciences and Numerical Simulation*. 2010;11(9):755–775.
4. Hunter WW, Stewart JR, Eccles KA, et al. Three-Strand Cable Median Barrier in North Carolina. *Transportation Research Record: Journal of the Transportation Research Board*. 2001;1743(1):97–103.
5. Karpov IA. Razrabotka konechno-ehlementnykh modelei trosovykh dorozhnykh ograzhdenii s ispol'zovaniem programmogo kompleksa LS-DYNA [Development of finite element models rope guardrails using the software package LS-DYNA]. *Avtomobil'. Doroga. Infrastruktura*. 2014;2(2):38. Available from: URL: https://www.adi-madi.ru/madi/article/view/91/pdf_36 (accessed: 08.01.2021). (In Russ.)
6. Kolesnikova GP, Gasainiev AR. Priblizhennoe matematicheskoe modelirovanie traektorii dvizheniya ATS pri kosom naezde na bokovye trosovye ograzhdeniya [Approximate mathematical modeling of the trajectory of the ATS at an oblique hitting the side of a cable fence]. *Avtomobil'. Doroga. Infrastruktura*. 2018;1(15):2. Available from: URL: <https://www.adi-madi.ru/madi/article/view/515> (accessed: 08.01.2021). (In Russ.)
7. Rainus GE. Raschet mnogoproletnykh trosov i mnogoproletnykh ferm iz trosov [Calculation of multispan cables and multispan cable trusses]. Leningrad: Stroizdat; 1968. 135 p. (In Russ.)
8. Demyanushko IV, Obshech AG. Raschetno-ehksperimental'nyi analiz trosovykh dorozhnykh ograzhdenii bezopasnosti [Computational and experimental analysis of cable road safety fences]. In: Collection of papers on Questions of construction mechanics and reliability of machines and structures. Moscow: MADI Publ. House; 2012. P. 34–44. (In Russ.)
9. Bateman MB, Howard IC, Johnson AR, et al. Validation of a computer simulation of the impact performance of a wire rope safety fence. In: Proceedings of the Institution of Mechanical Engineers, Part C: Journal of Mechanical Engineering Science. 2007;221(12):1557–1570.
10. Drong BI, Dubinin VV, Ilyin MM, et al. Kurs teoreticheskoi mekhaniki [Course of theoretical mechanics], 5th rev. ed. Moscow: Bauman University Publ. House; 2017. 580 p. (In Russ.)
11. Kolesnikova GP. Analiticheskii raschet kinematicheskikh kharakteristik avtomobil'nogo transportnogo sredstva pri kosom naezde na bokovye trosovye ograzhdeniya s uchedom udara [Analytical calculation of the kinematic characteristics of an automobile vehicle with oblique collision with side cable barrier with impact taken into account]. *Avtomobil'. Doroga. Infrastruktura*. 2019;4(22):1. Available from: URL: https://www.adi-madi.ru/madi/article/view/833/pdf_480 (accessed: 08.01.2021). (In Russ.)
12. Olson RM, Post ER, McFarland WF. Tentative service requirements for bridge rail systems. Highway research board. National academy of Sciences – National research council. 1970. Available from:

http://onlinepubs.trb.org/Onlinepubs/nchrp/nchrp_rpt_86.pdf. (accessed: 02.11.2020).

13. Kolesnikova GP. Priblizhennyye metody analiticheskogo modelirovaniya traektorii dvizheniya ATS pri kosom naezde na bokovye trosovye ograzhdeniya [Approximate methods of analytical modeling of the trajectory of motor vehicle movement at an oblique hitting the side of a cable barrier]. Avtomobil'. Doroga. Infrastruktura. 2018;(16):3. Available from: URL: https://www.adi-madi.ru/madi/article/view/568/pdf_354 (accessed: 08.01.2021). (In Russ.)

Submitted 02.11.2020

Scheduled in the issue 25.01.2021

About the Author:

Kolesnikova, Galina P., lecturer of the Mechanics Department, Peter the Great Strategic Missile Troops Academy (8, Karbysheva St., Balashikha, 143900, RF), ResearcherID: [D-9839-2018](https://orcid.org/0000-0003-3392-9281), ORCID: <https://orcid.org/0000-0003-3392-9281>, kolesnikovagp@mail.ru

The author has read and approved the final manuscript.